

OPERATION AND INSTALLATION MANUAL

Quality First!

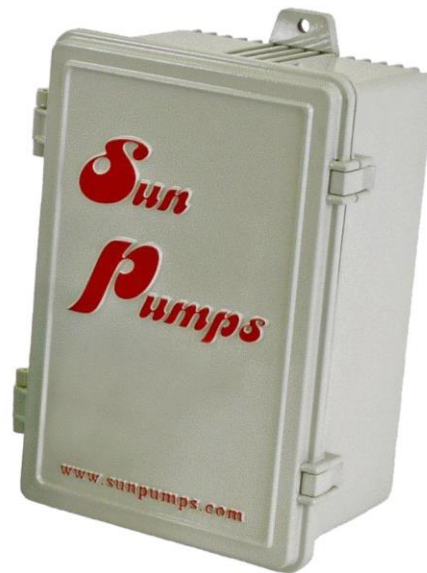

**Brushless
DC Motors**

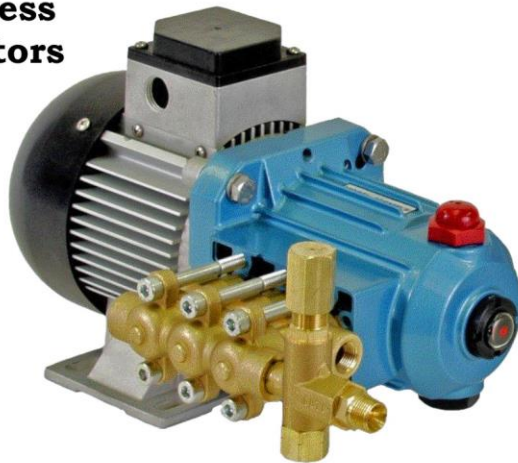

SIJ SERIES SOLAR ELECTRIC TRIPLEX PLUNGER PUMPS

Manufactured & Serviced By:

**SunPumps, Inc.
325 E. Main St.
Safford, AZ 85546
(928) 348-9652**

***Independent Water
Pumping Systems***

**Made In America
ARRA Compliant**

Table of Contents

Introduction	1.0
Precautions	
Product Overview	2.0
Table 1: Differences in Controller Models	
Controller Features	2.1
Application	2.2
Installation and Operation	3.0
Warning	
Location	3.1
System Design Basics	3.2
Pump Installation	3.3
Inlet Condition Check-List	
Wiring	3.4
Figure 1: PCA Controller and Motor Wiring Connections	
Figure 2: PCA Controller Wiring Diagram (Auxiliary)	
Figure 3: PCA Dip Switch Settings	
Figure 4: PCC Controller Wiring Diagram	
Figure 5: PCC Dip Switch Settings	
Controller Settings	3.5
Auxiliary Control Circuits	3.6
Over-Current Shut-Down Circuit	
Sensor Low Water Cutoff	
Remote Switch	
Low Power Shut-Down Circuit/Sensorless Low Water Shut-Down Circuit	
Output Power Limit Circuit	
Troubleshooting	4.0
Controller does not turn on	
Controller turns on but pump does not run	
Pump is running but the output is low	
Pump draws excessive current	
Before Calling Sun Pump	
Table 2: Friction Loss Table	
Table 3: Preventive Maintenance Chart	
Warranty Statement	6.0

Phone (928) 348-9652 Fax (928) 348-9653

1.0 Introduction

Thank you for selecting a SunPumps SIJ series solar plunger pump system. The SIJ series pump and PC series Sensorless Brushless DC pump controller are the key components to high quality solar powered pumping systems. Their stand-alone, pollution free and low noise operation makes them an ideal solution for high pressure and high head pumping applications such as pumping up high hills or injection water or chemicals into a high pressure system. The operating pressure can be as high as 2000 PSI, depending on the pump model.

SunPumps SIJ series systems are solar powered, triplex plunger pumps, utilizing a sensorless brushless DC motor. The brushless DC motors are constructed of high quality, anodized, die-cast aluminum and the controller is mounted in a powder coated, die cast, NEMA 3R enclosure. These pumps are designed specifically for water delivery in remote locations.

The PCA-BLS series controllers are microprocessor based solid state DC power converters designed as the interface between a solar module array and a three phase sensorless brushless DC pump motor. The purpose of the controller is to operate the high efficiency, high reliability DC motor and maximize the total daily water output while providing protection for the pump, as well as providing an interface with other related pumping system equipment.

Although these SIJ series pump systems are easy to install, please read this manual to become familiar with the pump and controller features, functions, connection points and various configurations. For future reference, keep this manual and other relevant product information in a safe place.

PRECAUTIONS

Safety First – Always understand what you are doing when working with any form of electricity. Guessing at something is not worth the potential of product damage and/or severe personal injury.

- **Shut down all power when working on the system.**
- **Do not feed live wires into the PCA-BLS-M2. Personal injury or other damage may result.**
- **Do not exceed the voltage rating of the controller.**
- **Do not start or run the pump dry.**
- **Do not splash water on the controller when the cover is open.**
- **Mount the controller in a shaded, well vented, *vertical* position.**
- **Installation of this system should be done by a licensed Pump Contractor.**
- **Verify wiring connections between the controller and the motor before starting the pump.**

2.0 Product Overview

The SunPumps PCA-BLS-M2 and PCC-BLS-M2 series controllers were designed specifically for SunPumps Sensorless Brushless DC motors. When properly installed and configured, the features incorporated into this stand-alone system will control and protect your pump system permitting many years of dependable, trouble free service. SunPumps has produced multiple versions of this controller. The notable differences are certain set points and electrical characteristics which are detailed in the table below.

Table 1

Controller Model	Min Voltage ¹	Max Voltage	Min Power	Max Power	Low Water Cutoff Min	Low Water Cutoff Max	Nominal Voltage
PCA-60BLS-M2	30 V	100 V	Set by LWC	840 W	50 W	300 W	60 V
PCA-120BLS-M2	90 V	200 V	Set by LWC	1440 W	50 W	500 W	120 V
PCC-120BLS-M2 ²	90 V	200 V	Set by LWC	1500 W	100 W	585 W	120 V
PCC-180BLS-M2 ²	120 V	300 V	Set by LWC	2250 W	100 W	1023 W	180 V
PCC-240BLS-M2 ²	220 V	380 V	Set by LWC	3000 W	100 W	1023 W	240 V

¹Min Voltage is the minimum voltage which the unit must see in order to start the pump. If this voltage is not obtained, the unit will not attempt to start the pump. Voltages lower than this will not hurt the unit.

²All controller models have the same basic operating features, functionality and setup. Voltage and power tolerances are the only differences of concern to the end user. This manual will only differentiate when necessary for clarity.

2.1 Controller Features

1. Current boosting for matching the load requirements of the pump.
2. Voltage regulation of the solar electric array at its maximum power point. (MPPT)
3. Over-current protection via integrated electronic circuit breaker.
4. Reverse polarity protection (10 amperes maximum) on the input terminals.
5. Voltage and current limiting to pump motor.
6. Transient protection and surge suppression.
7. Adjustable output motor power control for precision output flow.
8. Digital display indicating status, power, voltage, current and more. (PCC Series Only)
9. System ON/OFF switch.
10. LED indicators; 1. Power In, 2. Motor Run, 3. MPPT, 4. RS Stop, 5. Low Power, 6. Over-Current, 7. Fault Condition.
11. Weather resistant powder coated, die cast aluminum enclosure with a hinged door.
12. Rising clamp screw terminal blocks – no fork terminals required.
13. Pre-adjusted pump configuration and power source selection.
14. Remote switch interface – float switch or remote shutdown –Normally Open or Normally Closed, user selectable.
15. Sensorless “Low Water” circuit
16. Low Power Shut Down circuit

2.2 Application

The only application the PCA & PCC-BLS series controllers are designed for is the interface between a solar module array and SunPumps Sensorless Brushless DC motors.

No other applications or DC power sources are recommended or warranted unless written approval is provided by the SunPumps factory.

3.0 Installation and Operation

The following sections are outlined in a step-by-step format to guide you through the installation and configuration of an SIJ series pump and PCA & PCC series controller. The procedure for installing the SIJ triplex plunger pump is the same as any standard AC plunger pump. Any licensed pump contractor will be familiar with the proper installation procedures. The installation and operation should be in accordance with local regulations, accepted codes of good practice and common sense. This pump should be installed by a licensed professional pump installer.

Before installing any pump system read all product manuals then review all system components to become familiar with the physical and electrical layout. Check all equipment for any product damage. Refer to applicable figure(s) as a guide during the installation. Controller door must be closed during normal operation.

Warning

Reverse polarity on a panel system capable of producing over 10 amps will result in non-warranted product damage. Please check polarity before connecting power to the controller.

This controller is for SunPumps Sensorless Brushless DC Motors only. Do not use this controller on AC, Brush-Type or Sensor Type Brushless DC motors. Damage to the controller and/or motor will result.

Caution

All High Pressure Systems require a primary pressure regulating device (i.e. regulator, unloader) and a secondary pressure relief device (i.e. pop-off valve, relief valve). Failure to install such relief devices could result in personal injury or damage to pump or property. SunPumps does not assume any liability or responsibility for the operation of a customer's high pressure system. Read all CAUTIONS and WARNINGS before commencing service or operation of any high pressure system. The CAUTIONS and WARNINGS are included in each service manual and with each Accessory Data sheet.

3.1 Location

As the majority of system installations vary greatly, only general comments can be made as to location. Prior to installing the system, it is suggested to make a system layout plan. During the system layout, take into consideration any potential shading of the solar electric modules, wire runs, wire size, conduit runs, trenching, controller accessibility, tank location, pump head etc. Shading even a small portion of the array can reduce the output of the entire array and thus reduce or completely stop the output of the pump. There is no substitute for a good plan! Always follow State and Local Building Codes.

The PCA or PCC series controller can either be mounted indoors or outdoors. Locate all system equipment as close as possible to each other. For top of pole mount racks, the controller is usually mounted on the north side (shaded side) of the mounting pole. The controller must be mounted in a vertical position for proper cooling and to keep the electronics dry. The pole should be located close to the well (bore hole). This general physical layout is conducive to clean installation both aesthetically and electrically.

3.2 System Design Basics (Read carefully before installation)

1. The pump discharge piping should be sized for efficient pump operation. We suggest using the Friction Loss Tables (Table 2) to calculate the Total Dynamic Head using different pipe sizes. Use no less than a 1/2" suction pipe and increase the pipe size if the run is over 3 feet.
2. For optimum pump performance make sure that the wire is sized properly for the length of run between the pump and the solar modules. Wire sized too small will cause a decreased output from the pump. Keep the distance from the solar modules to the pump as short as possible. Refer to a DC wire loss chart for proper sizing. It is recommended to keep the voltage drop under 3%.
3. The SIJ series triplex plunger pumps have poor suction lift capabilities and require a flooded suction or positive head on the suction. Positive head can be up to 75 PSI.
4. Always fill the suction pipe and the pump with water before you turn the pump on. If the pump is operated dry, damage to the pump will occur and dry running is not covered under warranty.
5. If pumping from a tank or any source that could run low on water, install a low water float switch to protect the pump from running dry.
6. If a pressure switch is used in the system, choose one with a Low Pressure Cut-Off. If the pump runs dry the pressure will drop and the low pressure switch will turn the pump off.
7. Never install the controller in direct sunlight. Direct sunlight on the controller may cause over-heating of the controller.
8. Never lay the controller on the ground or mount the controller in a horizontal position. **The controller should be mounted in a vertical position only.** A convenient place to mount the controller is on the north side (shaded side) of the solar module array.
9. The controller should be grounded to the pump motor housing, the frame of the solar modules and to an 8-foot ground rod with a AWG #8 wire. If the well casing is steel it may be used as the ground rod. Drill and tap a hole in the casing or weld a bolt to the casing for the ground lug. Use only a copper lug to attach the ground wire. The cemented support structure pole will not provide an adequate ground. Do not ground the positive or negative electrical wires. Always use a DC surge/lightning arrester on the panel side of the controller. (Midnight Solar MN-SPD surge arrester is recommended)
10. Do not ground the array positive or negative electrical wires.

3.3 Pump Installation

1. Write the pump, motor and controller model number and serial number in the space provided on the last page in this Instruction Manual. This information will be needed when filling out the Warranty Card. And will aide in any troubleshooting if necessary.
2. Inspect all components for shipping damage and insure that you have all the components that are required for a complete installation.
3. Locate the pump on a flat surface close to the water source but do not mount in direct sunlight. The motor requires free circulation of air so always install in a well-ventilated and dry area. The motor should be kept dry and out of the rain and weather.
4. Keep the suction line as short and as direct as possible. This reduces the friction losses through the pipe and fittings. The suction line should have continuous slope from the lowest point in the line to the inlet of the pump. Make sure there are no loops or high spots in the suction line that could trap air. To avoid air pockets, slope the horizontal pipe continuously upward from the water source to the pump by at least 1" for every 30" of horizontal run.
5. Make sure the suction joints are tight. The suction line should be the 1/2" or larger. Increase the pipe size to 3/4" if the pipe run is over 3 feet.
6. The SIJ series pump includes an unloader valve on the discharge side of the pump. Make sure it is adjusted to relieve at a pressure that is under the pressure rating of the pipeline.
7. Always fill the suction pipe and the pump with water before you start the pump. Always use a pipe thread sealant.

Inlet Condition Check-List

Review Before Start-Up

Inadequate inlet conditions can cause serious malfunctions in the best designed pump. Surprisingly, the simplest of things can cause the most severe problems or go unnoticed to the unfamiliar or untrained eye. **REVIEW THIS CHECK-LIST BEFORE OPERATION OF ANY SYSTEM.** Remember, no two systems are alike, so there can be no **ONE** best way to set-up a system. All factors must be carefully considered.

INLET SUPPLY should be adequate to accommodate the maximum flow being delivered by the pump.

1. Open inlet shut-off valve and turn on water supply to avoid cavitating pump. **DO NOT RUN PUMP DRY.**
2. Temperatures above 130°F are permissible. Add 1/2 PSI inlet pressure per each degree F over 130°F. RPM changes may be required.
3. Avoid closed loop systems without a Thermo Valve high temperature protection.
4. Avoid low vapor pressure and high viscosity liquids.
5. Higher temperature liquids tend to vaporize and require positive heads.
6. When using an inlet supply reservoir, size it to provide adequate liquid to accommodate the maximum output of the pump, generally a minimum of 6-10 times the GPM (however, a combination of system factors can change this requirement); provide adequate baffling in the tank to eliminate air bubbles and turbulence; install diffusers on all return lines to the tank.

INLET LINE SIZE should be adequate to avoid starving the pump.

7. Line size must be a minimum of one size larger than the pump inlet fitting. Avoid thick walled fittings, tees, 90 degree elbows or valves in the inlet line of the pump to reduce the risk of flow restriction and cavitation.
8. The line **MUST** be a FLEXIBLE hose, NOT a rigid pipe, and reinforced on SUCTION systems to avoid collapsing.
9. The simpler the inlet plumbing the less the potential for problems. Keep the length to a minimum, the number of elbows and joints to a minimum (ideally no elbows) and the inlet accessories to a minimum.
10. Use pipe sealant to assure air-tight, positive sealing pipe joints.

INLET PRESSURE should fall within the specifications of the pump.

11. Optimum pump performance is obtained with +20 PSI (1.4 BAR) inlet pressure. With adequate inlet plumbing, most pumps will perform with flooded suction. Maximum inlet pressure is 75 PSI (5.25 BAR).
12. After prolonged storage, pump should be purged of air to facilitate priming. Disconnect any discharge port and allow liquid to pass through pump.

INLET ACCESSORIES are designed to protect against over pressurization, control inlet flow, contamination and provide ease of servicing.

13. A shut-off valve is recommended to facilitate maintenance.
14. A stand pipe can be used in some applications to help maintain a positive head in the inlet line.
15. Inspect and clean inlet filters on a regular schedule.
16. A pressure gauge is recommended to monitor the inlet pressure and should be mounted **AS CLOSE TO THE PUMP INLET** as possible. Short term, intermittent cavitation will not register on a standard gauge.
17. All accessories should be sized to avoid restricting the inlet flow.
18. All accessories should be compatible with the solution being pumped to prevent premature failure or malfunction.

BY-PASS TO INLET Care should be exercised when deciding the method of by-pass from control valves.

19. The SIJ Series pumps come standard with a Regulating Unloader to handle by-pass liquid directed to the inlet line of the pump. If other than standard valve is used, exercise caution to use proper flexible hose and adequate diameter.
20. A low-pressure flexible cloth braid (not metal braid) hose should be used from the by-pass connection to the inlet of the pump.

3.4 Wiring

Prior to connecting any wires to the controller, be sure you have a system wiring diagram to use as a reference (see figure 1). Guessing at polarity and connection points is not worth the risk of potential product damage and/or personal injury.

Ensure the wire sizes are of adequate diameter (gauge) to minimize voltage drop. Please refer to a DC voltage loss table or call your SunPumps dealer for assistance. Wire gauge being too small will cause excessive voltage losses to the motor and will reduce the flow rate of the pump.

All other system equipment should be installed before proceeding with wiring the controller. Double check polarity and wire termination tightness before powering up the system.

CAUTION: Photovoltaic panels produce DC electricity when exposed to sunlight. Cover the panels with a blanket or with a non-opaque material before wiring. Install a disconnect switch between the solar modules and the controller.

Follow the proper color code between the controller and the motor terminals. If the motor turns in the reverse direction the impeller and diffuser will be damaged and this is not covered under warranty.

1. After mounting the controller, turn the on/off switch to the OFF position.
2. If you are using a remote switch, like a float switch, set dip switch 1 to the correct position for the type of switch being used. (“Normally Open” or “Normally Closed”). If you are not using a remote switch leave switch 1 off.
3. Verify all remaining dip switches are off at this time.
4. Connect ground rod conductor to the controller chassis ground block.
5. Connect solar module frame ground conductor to controller chassis ground block.
6. Connect the green pump ground conductor to controller chassis ground block.
7. Connect pump motor leads to the corresponding “Pump Motor” terminals on the controller. Red to “Red”, Yellow to “Yellow” and black to “Black”.
8. Verify the disconnect switch is in the off position. Connect the DC source supply negative (-), the black conductor, to one of the controller terminals labeled “Negative” on the “Solar Array Input”. (NOTE: The power should be connected to a disconnect switch and it should be in the OFF position before connecting power to the controller).
9. Connect the DC source supply positive (+), the red conductor, to one of the controller terminals labeled “Positive” on the “Solar Array Input”. (NOTE: The power should be connected to a disconnect switch and it should be in the OFF position before connecting power to the controller).
10. Refer to the next section for “Remote Switch” connections and “Adjustment Procedures” for configuration, if applicable. Sensor type low water cutoff is supported by the controller but not for booster pumps at this time. If you would like to use one contact SunPumps for assistance.
11. At this point, all system components are installed and wired, double check conductor polarities, wire termination tightness and controller configuration. With a DC volt meter check the array open circuit voltage (Voc) on the array side of the disconnect switch and the module polarity. Record the Voc for future reference. You may do this on the Before Calling Sun Pumps Worksheet near the end of this manual. Check this voltage reading against the “Voc” range for your specific system in the chart below. (Figure 3)
12. After you have verified the voltage and polarity, switch the disconnect switch on - if the polarity is correct the first LED light will be on.
13. Turn the “On/Off” switch to the ON position. The system should be operational. If the system does not start and turns on any error lights or gives you an error message, proceed to the troubleshooting guide.

Figure 1

PCA Controller Wiring Diagram

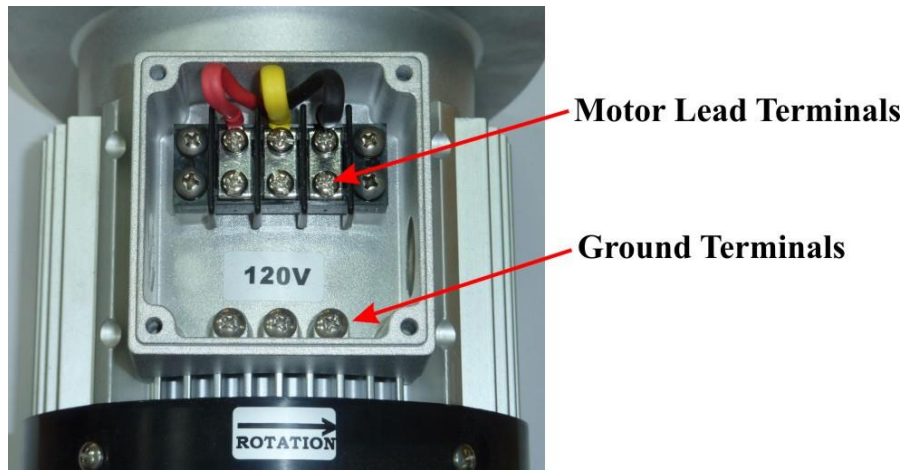
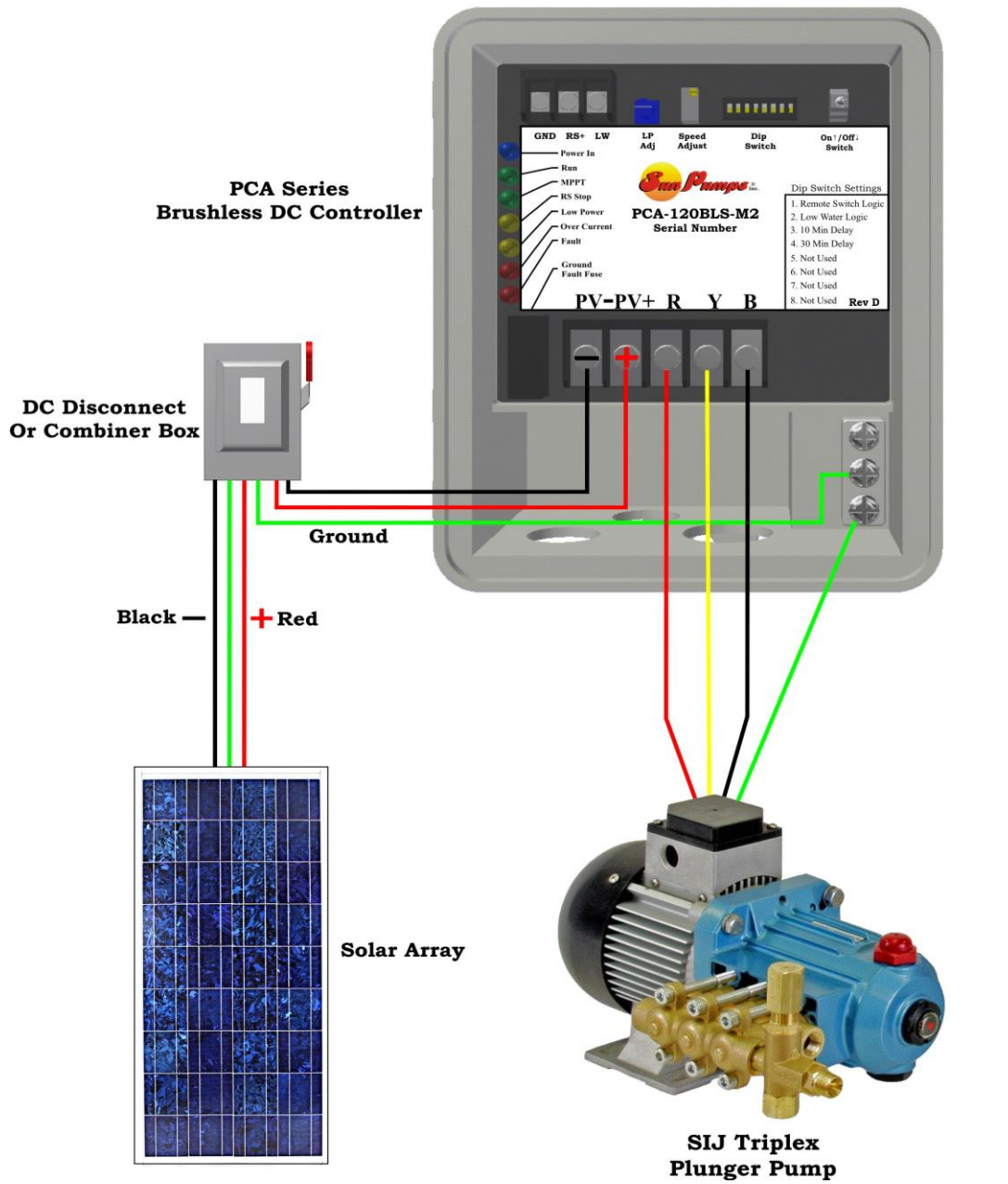

Motor Electrical Junction Box

Figure 2

PCA Controller Wiring Diagram
(Auxiliary)



Figure 3

PCA Dip Switch Settings

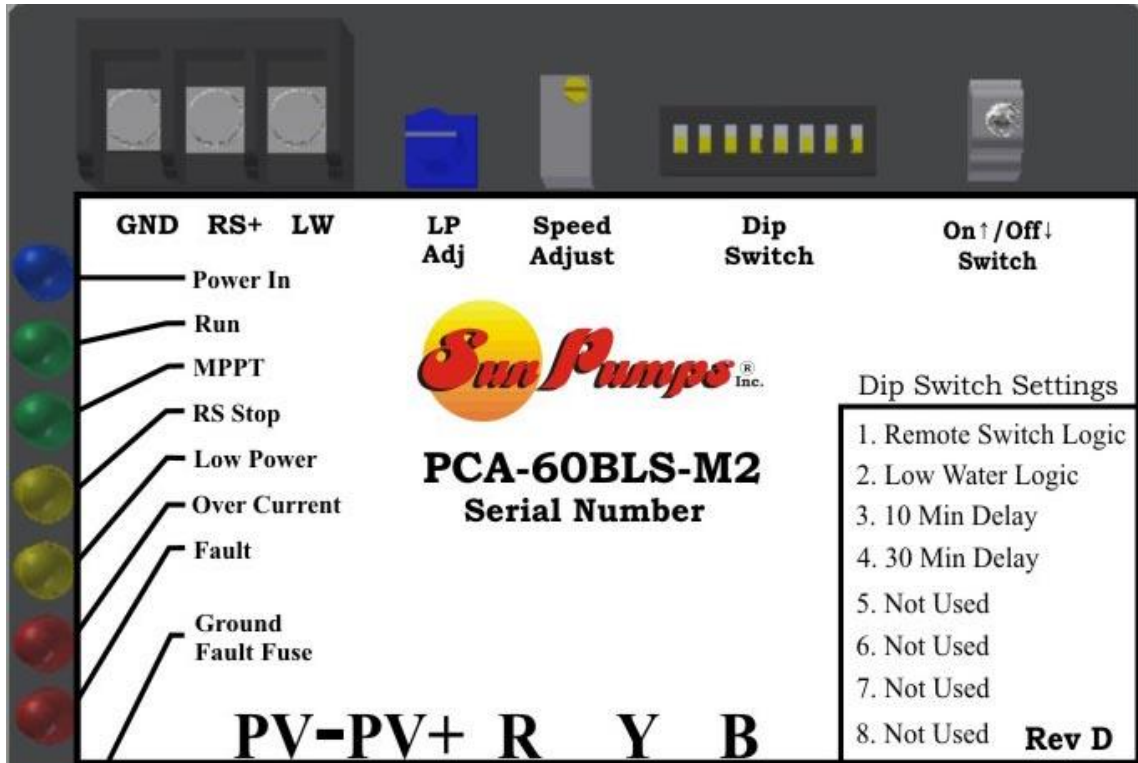

Switch Number	Switch Position	Description	Function	Default Setting
1	OFF	Remote Switch Logic	Turns pump off when terminals connect.	OFF
1	ON	Remote Switch Logic	Turns Pump on when terminals connect.	OFF
2		Low Water Logic		OFF
3		Low Water 10 Minute Time Delay		OFF
4		Low Water 10 Minute Time Delay		OFF
5		Not used at this time	Should be in the off position for proper operation	OFF
6		Not used at this time	Should be in the off position for proper operation	OFF
7		Not used at this time	Should be in the off position for proper operation	OFF
8		Not used at this time	Should be in the off position for proper operation	OFF

Figure 4

PCC Controller Wiring Diagram

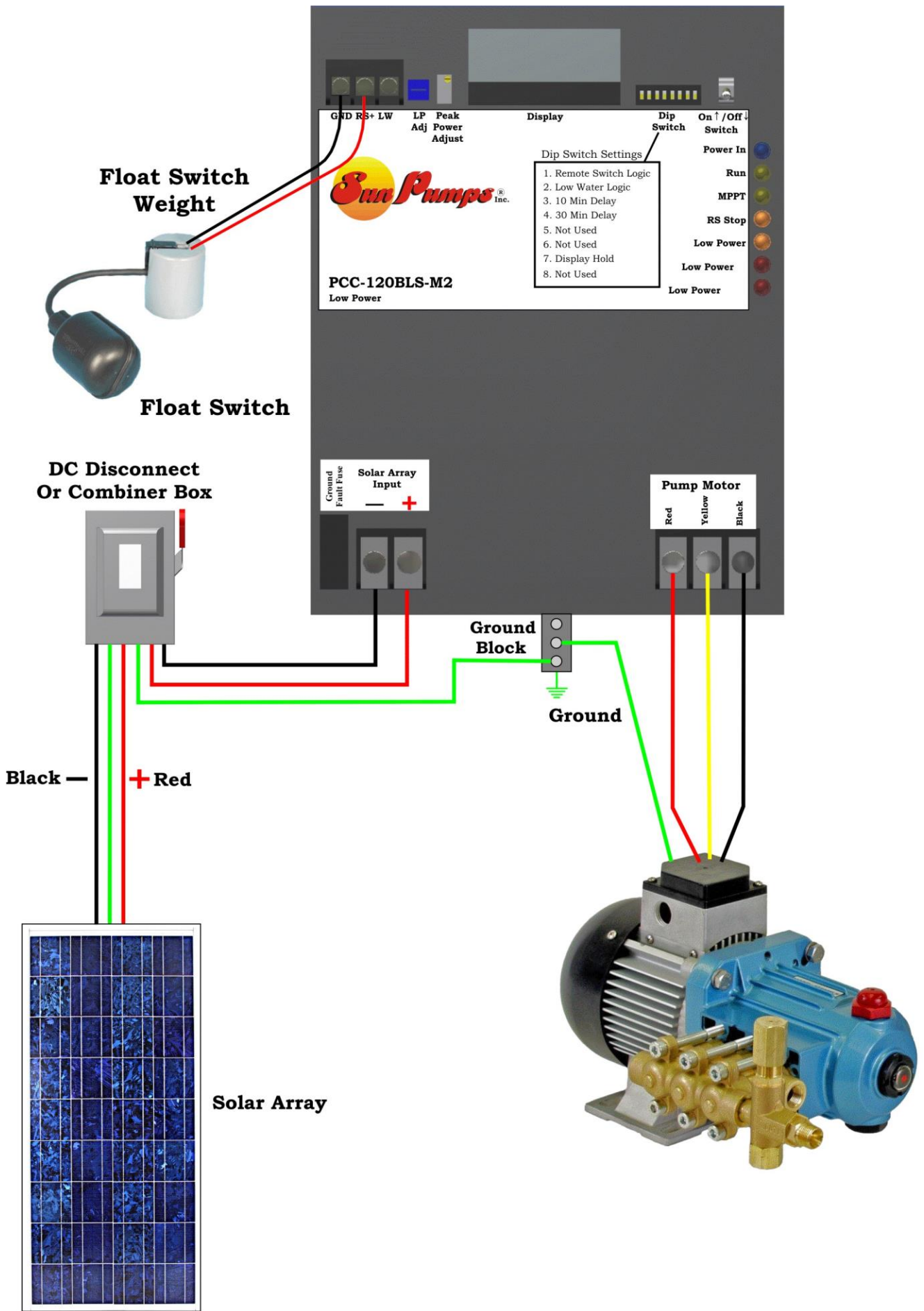
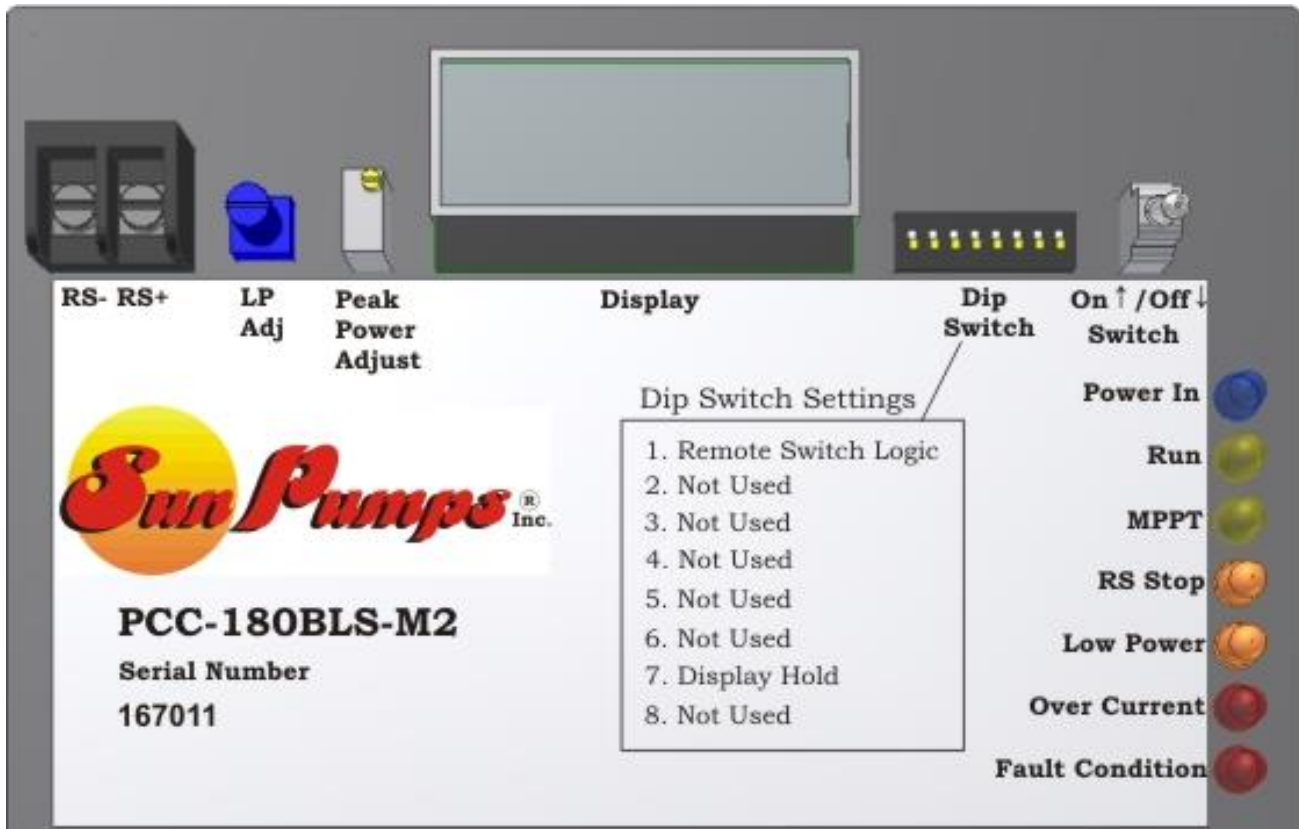

Figure 5

PCC Dip Switch Settings



Switch Number	Switch Position	Description	Function	Default Setting
1	OFF	Remote Switch Logic	Turns pump off when terminals connect.	OFF
1	ON	Remote Switch Logic	Turns Pump on when terminals connect.	OFF
2		Not used at this time	Should be in the off position for proper operation	OFF
3		Not used at this time	Should be in the off position for proper operation	OFF
4		Not used at this time	Should be in the off position for proper operation	OFF
5		Not used at this time	Should be in the off position for proper operation	OFF
6		Not used at this time	Should be in the off position for proper operation	OFF
7	ON	Display Freeze	Holds display on current screen	OFF
8		Not used at this time	Should be in the off position for proper operation	OFF

3.5 Controller Settings

The PCA & PCC-BLS series controllers have several settings (see figure 3 & 5). Most features include system configuration adjustments, some of which are user selectable by an eight position DIP-switch located on the face of the controller.

PCA Controller (Figure 3)

Switch 1 is the Remote Switch Logic. With this switch off (down), terminals “RS+” and “GND” must be connected to turn the controller off. With this switch on (up), terminals “RS+” and “GND” must be connected to turn the controller on.

Switch 2 is the Low Water Cutoff Logic. With this switch off (down), terminals “RS+” and “GND” must be connected to turn the controller off. With this switch on (up), terminals “RS+” and “GND” must be connected to turn the controller on. If you want to use this feature with the booster pump system, contact SunPumps for further assistance.

Switches 3 and 4 are delay timer adjustments. The delay timer is used for the remote switch and the low water cutoff. This timer by default is set for a 3 minutes. Switch 3 will increase the timer to 10 minutes; Switch 4 will increase it to 30 minutes. See Remote Switch and Low Water Cutoff for more information.

Switches 5, 6, 7 and 8 are not used at this time and should remain down.

PCC Controller (Figure 5)

The PCC series controllers have several settings (see figure 3). Most features include system configuration adjustments, some of which are user selectable by an eight position DIP-switch located on the face of the controller.

Switch 1 is the Remote Switch Logic. With this switch off (down), terminals “RS+” and “RS-” must be connected to turn the controller off. With this switch on (up), terminals “RS+” and “RS-” must be connected to turn the controller on.

Switch 7 is used to control the user interface. When switch 7 is down, the LCD will display various screens conveying pump and controller operating parameters. The display will cycle through each screen at a predetermined rate. For troubleshooting and some setup features certain screens are desired. By turning the switch number 7 on, the display will stop cycling and the current screen will stay on the display.

Switches 2, 3, 4, 5, 6, and 8 are not used at this time and should remain down.

3.6 Auxiliary Control Circuits

The auxiliary control circuits are configured and controlled with the “Dip Switches”, “LP Adj.”, “Speed Control” and the “RS”, “LW” and “GND” terminals. (See Figure 3)

These circuits offer expanded capability and are described here. The remote switch control is for float switches (storage tank level), pressure switches or a remote system “ON/OFF” toggle switch. The motor speed control is for adjusting the flow rate of the pump. There is also the low water cutoff, low power shut down and over current protection circuits. See each corresponding detailed description below.

NOTE: Use only “Shielded Wire” to run from the remote switch to the controller and the ground wire must be grounded to the controller side only. Induced voltages from lightning storms or two-way radio transmissions could damage the controller.

Over-Current Shut Down Circuit

The Over-Current shut down circuit will turn the controller off any time the current exceeds the current limit of the controller. When it turns the controller off it will remain off for 3 minutes and then turn on again. When it turns off an error light will light and the display will say Over-Current. When it turns on again, if it is still pulling excessive current it will continue to shut down for 3 minutes and try to restart.

Sensor Low Water Cut-off Circuit

The sensor type low water cutoff circuit is designed as a safety feature to protect your pump from running dry or your tank from overflowing. This feature is designed for use in the submersible SCS systems with the ground wire installed. For use with the SCB, SCP or SIJ systems contact SunPumps for assistance. The “LW” terminal of the controller should be attached to a low water sensor electrode which is mounted in your tank or well. The system can be used to detect low water or to detect high water depending on the position of switch 2 on the dip switch. When dip switch 2 is in the off position, the low water cutoff circuit expects not to touch water. If water comes into contact with it, and completes the circuit to ground, the pump will shut off until the water is removed and the delay timer times out. A three minute timeout is default for this feature but is modifiable by switches 3 and 4 to 10 or 30 minutes respectively. This timeout applies for low water cutoff only.

Remote Switch

The Remote Switch interface can serve as an automatic system shutdown when used with a water storage tank mounted float switch, a pressure switch or it can also serve as a manual system shutdown with a remote system ON/OFF toggle switch. The remote logic circuit allows the use of standard “Pump-Up or Pump Down” float switches. Please refer to the following operation scenarios for configuration options.

With switch number 1 in the *OFF* position, the controller is configured to accommodate a Normally Open (N.O.) float switch or remote toggle switch. In this configuration the controller will operate as follows:

PUMP ON

float switch open = water tank low = pump ON

PUMP OFF

float switch closed = water tank high = pump OFF

With switch number 1 in the *ON* position, the controller is configured to accommodate a Normally Closed (N.C.) float switch, pressure switch or remote toggle switch. In this configuration the controller will operate as follows:

PUMP ON

switch closed = water tank low = pump ON

PUMP OFF

switch open = water tank high = pump OFF

A three minute timeout is default for this feature but is modifiable by switches 3 and 4 to 10 or 30 minutes respectively. This timeout applies to remote switch and low water cutoff.

Low-Power Shut-Down/Sensorless Low Water Cut-Off Circuit (LPLW)

The Low-Power Shut-Down/ Low Water Cut-Off Circuit (LPLW) turns the pump off any time the controller output power drops below a functional level. This may be caused by lack of power from the solar panels or from running out of water. This protects the pump in stall conditions and saves wear on the system when no or very little water is being pumped. This feature must be adjusted for your specific application.

This feature is always monitoring the output of the motor. If you are not interested in using this feature turn the “LP Adjust” trim pot fully counter-clockwise. This will give the pump the minimum low power set point possible.

LPLW Adjustment

The Low Water Cut-Off Circuit and the Low Power Shut-Down circuit are adjusted using the same trim pot labeled “LP Adj.” on the controller. The default is the arrow pointing straight up. This is sufficient for most systems but adjustment will maximize the life and output of your system. Follow the steps below to adjust this feature.

1. Turn the “LP Adj.” trim pot fully counter clockwise.
2. Turn the “Speed Control” trim pot counter clockwise until the pump is pumping the desired minimum flow. This may be down to 0 gal/min but is not recommended for proper pump cooling.
3. Turn the “LP Adj.” trim pot clockwise until the pump shuts off.
4. Reset the “Speed Control” trim pot back to the desired position.

Output Power Limit Circuit (Motor Speed Control)

The Output Power Limit Control circuit is used to control the speed of the pump motor and thus the flow rate of the pump. It is primarily used for low producing wells where the pump output is matched to the production rate of the well. However it can also be used any time specific flow rates are required.

Output Power Limit Adjustment

The purpose of this procedure is to adjust the output power of the controller and thus reduce the water flow of the pump. If tests show the pump will not produce the well capacity, then the controller “Speed Control” feature can be used to match the flow rate of the pump to the production of the well.

1. With the system installed and controller properly configured, allow the pump to run at full power at mid-day until the pump starts surging.
2. Slowly turn the “Speed Control” trim pot located on the face of the controller counter clockwise until the pump stops surging. This is the point where the pump flow rate equals the well production. This process will probably take a few attempts to “balance” the system for optimum water production. If maximum water is not a critical issue you may want to reduce the pumps flow rate an additional 5% to 10% to ensure the pump will not run dry.

(NOTE: The trim pot has a 15-turn range. It usually takes many complete turns in a counter-clockwise direction before you will notice any change in water output or output power on the display).

4.0 Troubleshooting

Sun Pumps, Inc. is dedicated to its customers and will gladly help you trouble shoot any problems with your system. However, especially during the busy summer pumping season, we may not be able to help you right away. Using this trouble shooting guide as your first resource when your system is not working properly can save you valuable time in getting your system fully functional. If at any time however, you are not comfortable performing any of these tasks, or do not fully understand the system, it is better to call than to guess. **Before calling please go through the section below labeled “Before Calling Sun Pumps” and complete the steps there.**

CONTROLLER DOES NOT TURN ON

1. Check the LED’s on the face of the controller. The top LED, labeled “Power In”, should be on. This indicates power is connected to the controller and the polarity is correct. If it is not on, verify that the controller is properly wired, including polarity, and that the input terminals have at least 30 volts. Less than 30 volts at the input terminals and the unit may show no signs of operation. If you do have at least 30 volts in the right polarity, contact Sun Pumps for further assistance.
2. If the expected voltage is not present, disconnect the panels from the controller using the disconnect switch, and check any fuses and breakers in the system. Replace blown fuses and reset tripped breakers.
3. If there are no blown fuses and no tripped breakers, check the open circuit voltage of your array. If the open circuit voltage is not correct, troubleshoot the array to find the problem. If the open circuit voltage is correct, call Sun Pumps for further assistance.

CONTROLLER TURNS ON BUT PUMP DOES NOT RUN

1. Make sure the On/Off switch is in the up position. (On)
2. The second LED is labeled “Run”. This indicates the pump is running. If it is on, go to the bore hole and listen for the sound of the motor. Check for breaks in the pipe. If you cannot find a problem call Sun Pumps for further assistance.
3. Check the fourth LED, labeled “RS Stop”; this is the remote switch shutdown indicator. If it is on, the remote circuit or low water cutoff circuit is preventing the controller from running the pump. Set the #1 and #2 dip switches to off and disconnect the remote switch and low water cutoff. Turn the switch off then back on. If the light goes out and the pump starts, troubleshoot the remote switch and low water cutoff individually. If the pump does not start and the LED is still lit, call Sun Pumps for further assistance.

4. Check the fifth LED, labeled “Low Power”; this is the low power shutdown indicator. If it is on, the controller detected a low power or low water condition. The low power shut down is a common occurrence on days which have clouds which block the sun momentarily. First check the input voltage to the controller. Verify that this exceeds the minimum voltage in Table 1. If it does not meet or exceed the minimum voltage, you do not have enough power to start your pump. **Note:** To accurately trouble shoot this feature there should be absolutely no clouds blocking the sun at any time during the following tests. If you have enough input voltage, turn the controller off then on again to reset this fault. If the low power or low water condition still exists then the controller will start but shut down again. Turn the blue pot labeled “LP Adj” all the way counter-clockwise. Cycle the pump off then on. If the pump does not shut down, the low water cutoff was causing the error. If you want to use this feature, readjust the low water cutoff as seen earlier in this manual. If the does not run properly, skip to step 7. Check to verify the pump is not running out of water. If your pump is not running out of water, call Sun Pumps for further assistance.
5. If the sixth LED, labeled “Over Current” is on, the controller has exceeded its current limit and shut down. Turning the controller off then on again will reset this fault. If the controller continues to need high current, it will turn itself off again. Verify the nominal voltage of your array. If the calculated V_{mp} for your array is higher than 200 V, the controller may go into over current. Remove one series panel from each string and try again. Check the pump for a short to ground using an ohm meter and call Sun Pumps for further assistance.
6. Check motor wiring and connections. Also check the ground fault fuse, it may have been blown.
7. Check your system for ground loops and replace the fuse with a 500 VDC 1A rated fuse. If this does not solve the issue, contact Sun Pumps for further assistance.
8. Check for proper dip switch settings on your controller. Switches 5, 6, 7, and 8 must be in the off position for proper operation.
9. Check for proper controller input voltage. If the pump is not running, the input voltage should be the array open circuit voltage, (Voc). Verify that this voltage is below the maximum input voltage allowed for your controller (model dependent see Table 1). Check the Voc on the label on the back of the solar modules and multiply this figure times the number of modules that are connected in series. This number should be + - 10% of the measured reading. If it is not then confirm all electrical terminations are tight and secure. Use a DC volt meter to check each solar module for proper open circuit voltage (Voc). One bad module will drop the voltage on the complete series string.

PUMP IS RUNNING BUT THE OUTPUT IS LOW

1. Make sure you have full sun light at midday, that there are no clouds and no shadows on any part of the array. Then verify power going into the controller by measuring the voltage and current. Check this against the pump chart for your specific application.
2. If the power is correct for your pump model and array size then make sure the pump wires are connected to the proper terminals. If two wires are reversed the motor will be running in reverse. It may still pump but not at the full rated output.
3. If the wires are correct verify that your system does not have any leaks where water can be lost. If you cannot determine the problem, contact Sun Pumps for further assistance.
4. Make sure the water in the well is not drawing down past the suction capability lift of the pump.
5. Check the suction screen on the foot valve to see if it is plugged.
6. Make sure the hole in jet nozzle is not plugged. (Part No. 41459)

PUMP DRAWS EXCESSIVE CURRENT (More than the rating of the pump, but less than the rating of the controller)

1. Check wiring diagram for proper connection.
2. Check for skinned wires or faulty underwater splice.
3. Check for locked motor armature. With the pump out of the well, remove the pump end from the motor (if this is not feasible skip this step and contact Sun Pumps). Allow the controller to attempt to start the motor. If the motor still does not run, contact Sun Pumps for further assistance.

BEFORE CALLING SUNPUMPS

If at all possible when calling Sun Pumps for technical support there are a few things which will help to speed up the process and help us determine the cause of and solution to the system failure. The best way to get help is to call while you are physically at the location of your pump, have good sunlight, and have a multimeter and a screwdriver with you.

Furthermore, please fill out the form below before calling. This information will provide us with most of the preliminary information we need to help you. If you cannot physically be at the site, filling out the worksheet is a must.

Pump Model Number: _____
Pump Serial Number: _____
Motor Serial Number: _____

Controller Model Number: _____
Software Version _____

Date Purchased: _____

Solar Module Specifications:
Model Number _____
Rated Watts _____
Voc _____
Vmp _____
Isc _____
Imp _____

Solar Modules Connected in Series _____ X Voc _____ = _____ Array Voc

Solar Modules Connected in Series _____ X Vmp _____ = _____ Array Vmp

Series Strings Connected in Parallel _____ X Isc _____ = _____ Array Isc

Series Strings Connected in Parallel _____ X Imp _____ = _____ Array Imp

Table 2

Flow Rate	HOSE FRICTION LOSS						
	Pressure Drop In PSI Per 100 Feet Of Hose						
	Hose Inside Diameters						
GPM	1/4"	5/16"	3/8"	1/2"	5/8"	3/4"	1"
0.5	16	5	2				
1	54	20	7	2			
2	180	60	25	6	2		
3	380	120	50	13	4	2	
4		220	90	24	7	3	
5		320	130	34	10	4	
6			220	52	16	7	1
8			300	80	25	10	2
10				120	38	14	3
15					80	30	7
20							12
25							19

Table 3

Preventative Maintenance Check-List						
Check	Daily	Weekly	50 Hours	500 Hours	1500 Hours	3000 Hours
Clean Filters	X					
Oil Level/Quality	X					
Oil Leaks	X					
Water Leaks	X					
Belts, Pulley		X				
Plumbing		X				
Initial Oil Change			X			
Oil Change				X		
Seal Change					X	
Valve Change						X
Accessories					X	
<p>Each system's maintenance cycle will be exclusive. If system performance decreased, check immediately. If no wear at 1500 hours, check again at 2000 hours and each 500 hours until wear is observed. Valves typically require changing every other seal change.</p> <p>Duty cycle, temperature, quality of pumped liquid and inlet feed conditions all effect the life of pump wear parts and service cycle so adjust to fit.</p> <p>Remember to service the regulator/unloader at each servicing and check all system accessories and connections before resuming operation.</p>						

Warranty Statement

SIJ Series Brushless DC Plunger Pumps PCA & PCC-BLS Series Pump Controllers *Limited Warranty – Twenty Four Months*

SunPumps warrants to the original consumer that its products shall be free from defects in material and workmanship under normal applications and service conditions for a period of twenty-four (24) months after the original date of purchase, but not to exceed thirty (30) months from the date of manufacture. This does not include the replacement of normal wear parts.

At its option, SunPumps will repair or replace any SunPumps product, which has failed due to a defect in material or workmanship during this warranty period, no other brand controller is authorized for use with this pump. A PC-BLS series controller must be installed in conjunction with the pump to validate the warranty. This limited warranty shall not apply if the SunPumps product has been damaged by unreasonable use, accident, negligence, mishandling, misapplication, alteration, modification, abrasion (sand damage to pump), shipping, service or modification by anyone (other than by SunPumps), or failure which are caused by products not manufactured by SunPumps, or should the products serial number being altered, or by damage that is attributable to an act of God, or by any other causes unrelated to defective materials or workmanship. Any disassembly whatsoever of the product voids all warranty.

The original purchaser MUST complete and send in the warranty registration card, with the pump serial number and the controller serial number for warranty validation. ***No warranty performance will be rendered without a valid warranty card on file at the SunPumps factory.***

There are no express warranties except as listed above. SunPumps shall have no responsibility for damage to property, persons, animals, or other loss or injury resulting from the use of a SunPumps product. The purchaser's exclusive remedy shall be only as stated herein. This warranty is in lieu of all other warranties expressed or implied.

Except for the warranty that the products are made in accordance with the specifications therefore supplied or agreed to by customer, SunPumps makes no warranty expressed or implied, and any implied warranty of merchantability or fitness for a particular purpose which exceeds the forging warranty is hereby disclaimed by SunPumps and excluded from any agreement made by acceptance of any order pursuant to this quotation.

UNDER NO CIRCUMSTANCES WILL SUNPUMPS BE LIABLE FOR ANY CONSEQUENTIAL OR INCIDENTAL DAMAGES, LOSS OR EXPENSE ARISING IN CONNECTION WITH THE USE OF OR THE INABILITY TO USE ITS GOODS FOR ANY PURPOSE WHATSOEVER. ALL PRODUCTS ARE SOLD AS IS WITH ALL FAULTS. SUNPUMPS MAXIMUM LIABILITY SHALL NOT IN ANY CASE EXCEED THE PURCHASE PRICE FOR THE GOODS CLAIMED TO BE DEFECTIVE OR UNSUITABLE.

SunPumps is not responsible for labor, transportation, and related costs incurred by the customer to make allegedly defective equipment available to the factory for inspection re-installation, lost profits or costs caused by interruption of service. SunPumps is not responsible for loss or damage to products, owned by customer and located on SunPumps premises, caused by fire or other casualties beyond SunPumps control.

This equipment is not to be used for anything other than its intended purpose as stated in this manual.

For future reference, please list your system data before installing the pump.

Installation Date _____

Pump Model _____

Pump Serial No. _____

Controller Model _____

Controller Serial No. _____

Warranty Card No. _____